



**PE**  
PRODUCTOS  
EUROPEOS

**CATALOGO  
VALLAS DE PVC**

[www.productoseuropeos.mx](http://www.productoseuropeos.mx)



# TIPOS DE VALLAS

## VALLA BARROTES

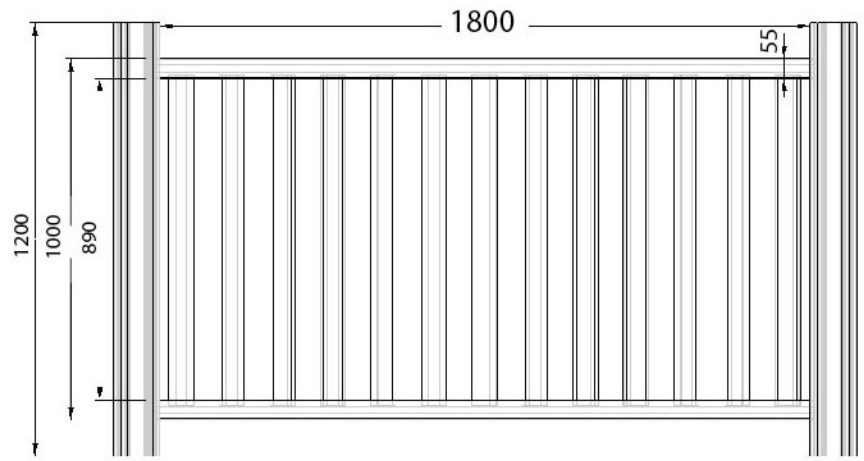
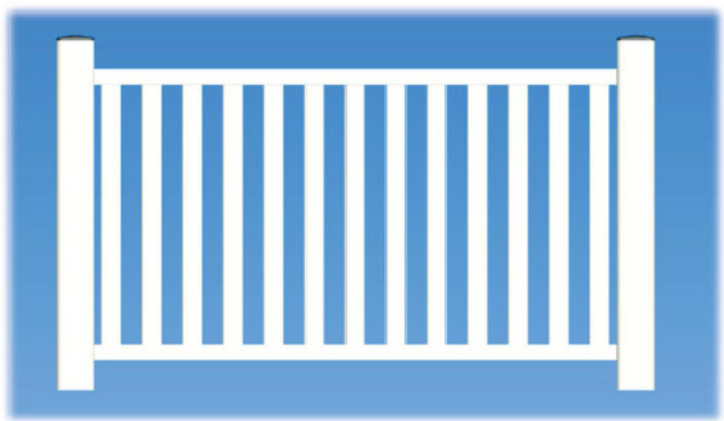

# TIPOS DE VALLAS

## VALLA BARROTES

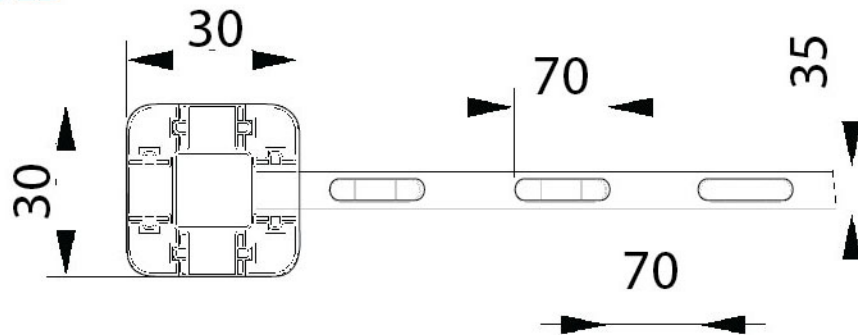

## PERFIL POSTE ENSAMBLABLE

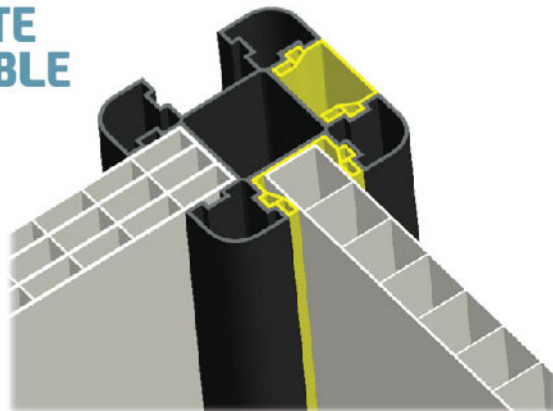

# TIPOS DE VALLAS

## VALLA DIVISORA

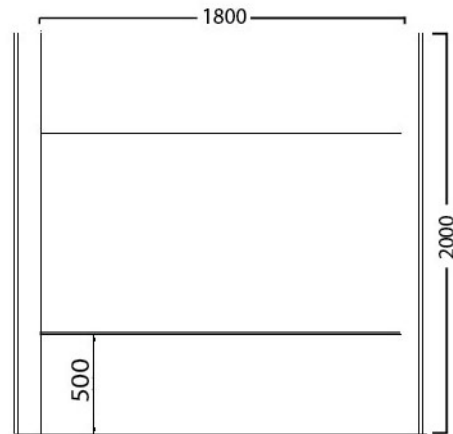
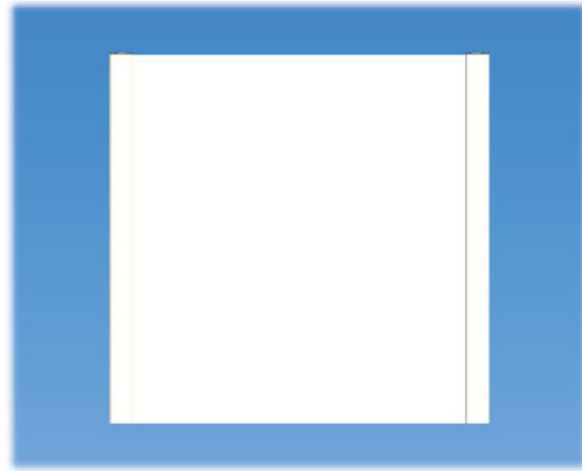

# TIPOS DE VALLAS

## VALLA DIVISORA

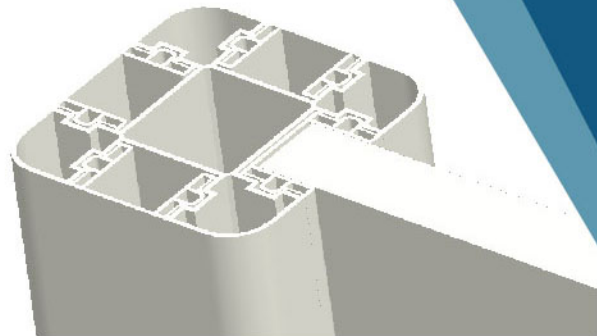

# TIPOS DE VALLAS

## VALLA MIXTA

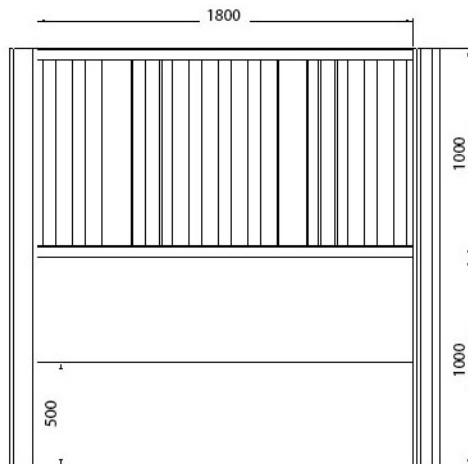
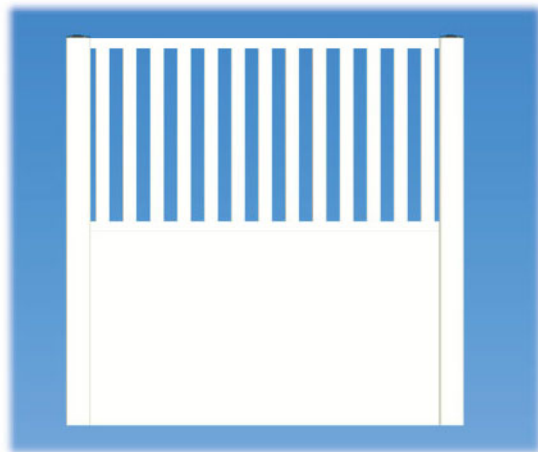

# TIPOS DE VALLAS

## VALLA MIXTA

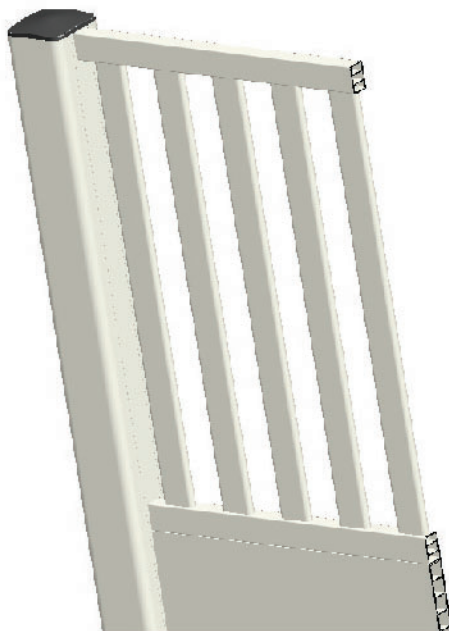
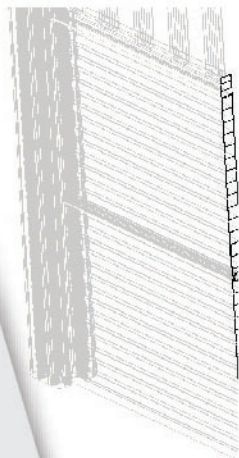



**PE**  
PRODUCTOS  
EUROPEOS

## SUCURSALES

### Guadalajara (Matriz)

Av. Gobernador Curiel # 1750  
Col. Morelos C.P. 44910  
Tel. +52 (33) 3812-9699  
3812-9688 Guadalajara, jal.

### Suc. México

Dom. Pekín No. 172  
Col. Aquiles Serdan C.P. 15430  
Tel. +52 (55) 1114-1200  
1114-8217 México, D.F.

[www.productoseuropeos.mx](http://www.productoseuropeos.mx)